



BiPAP Auto Bi-Flex

USER MANUAL



BiPAP Auto Bi-Flex

USER MANUAL



Table of Contents

Intended Use.....	2
Important.....	2
Warnings.....	2
Cautions.....	3
Contraindications	3
Symbol Key.....	3
System Contents.....	4
System Overview.....	4
Control Buttons.....	5
Available Therapies	5
Installing the Air Filters.....	6
Connecting the Breathing Circuit.....	6
Where to Place the Device.....	6
Supplying AC Power to the Device.....	6
Navigating the Device Screens.....	7
Starting the Device.....	7
Ramp Feature.....	8
Mask Fit Check Feature.....	8
Flex/Rise time Screen.....	9
Setup Screen	10
Info Screen.....	11
Device Alerts	13
Troubleshooting	16
Accessories	17
Traveling with the System	18
Cleaning the Device	18
Cleaning or Replacing the Filters	18
Cleaning the Tubing.....	18
Service.....	18
Specifications	19
Disposal.....	20
How to Contact Respironics	20
Limited Warranty.....	Back Page

CAUTION: U. S. federal law restricts this device to sale by or on the order of a physician.

Intended Use

The Respironics BiPAP Auto Bi-Flex system delivers positive airway pressure therapy for the treatment of Obstructive Sleep Apnea in spontaneously breathing patients weighing over 30kg (66 lbs). It is for use in the home or hospital/institutional environment.

Important

The device is to be used only on the instruction of a licensed physician. The system can deliver Bi-level therapy or Auto Bi-level therapy, both with and without Bi-Flex. The system can also deliver CPAP therapy. For enhanced pressure relief in CPAP mode, the device can deliver C-Flex. Your home care provider will make the correct pressure settings according to your health care professional's prescription.

When set in the Auto Bi-level therapy mode, the system will monitor your breathing as you sleep and automatically adjust the pressure to meet your needs. When in Bi-level or CPAP therapy, the system will deliver a continuous, set pressure during the night.

Several accessories are available to make your OSA treatment with the BiPAP Auto Bi-Flex system as convenient and comfortable as possible. To ensure that you receive the safe, effective therapy prescribed for you, use only Respironics accessories.

Warnings

A warning indicates the possibility of injury to the user or the operator.

- This manual serves as a reference. The instructions in this manual are not intended to supersede the health care professional's instructions regarding the use of the device.
- The operator should read and understand this entire manual before using the device.
- This device is not intended for life support.
- The device should be used only with masks and connectors recommended by Respironics or with those recommended by the health care professional or respiratory therapist. A mask should not be used unless the device is turned on and operating properly. The exhalation port(s) associated with the mask should never be blocked. **Explanation of the Warning:** The device is intended to be used with special masks or connectors that have exhalation ports to allow continuous flow of air out of the mask. When the device is turned on and functioning properly, new air from the device flushes the exhaled air out through the mask exhalation port. However, when the device is not operating, enough fresh air will not be provided through the mask, and exhaled air may be rebreathed. Rebreathing of exhaled air for longer than several minutes can in some circumstances lead to suffocation.
- If you are using a full face mask (a mask covering both your mouth and your nose), the mask must be equipped with a safety (entrainment) valve.
- If you are using the optional Respironics 15 mm tubing, the device tubing type setting must be set to 15. If your device does not have the tubing type setting, you must use the Respironics 22 mm tubing.
- When using oxygen with this system, the oxygen supply must comply with local regulations for medical oxygen.
- Oxygen supports combustion. Oxygen should not be used while smoking or in the presence of an open flame.
- When using oxygen with this system, turn the device on before turning on the oxygen. Turn the oxygen off before turning the device off. This will prevent oxygen accumulation in the device. **Explanation of the Warning:** When the device is not in operation and the oxygen flow is left on, oxygen delivered into the tubing may accumulate within the device's enclosure. Oxygen accumulated in the device enclosure will create a risk of fire.
- When using oxygen with this system, a Respironics Pressure Valve must be placed in-line with the patient circuit between the device and the oxygen source. The pressure valve helps prevent the backflow of oxygen from the patient circuit into the device when the unit is off. Failure to use the pressure valve could result in a fire hazard.
- Do not connect the device to an unregulated or high pressure oxygen source.
- Do not use the device in the presence of a flammable anaesthetic mixture in combination with oxygen or air, or in the presence of nitrous oxide.
- Do not use the device near a source of toxic or harmful vapors.
- Do not use this device if the room temperature is warmer than 35° C (95° F). If the device is used at room temperatures warmer than 35° C (95° F), the temperature of the airflow may exceed 43° C (109° F). This could cause irritation or injury to your airway.
- Do not operate the device in direct sunlight or near a heating appliance because these conditions can increase the temperature of the air coming out of the device.
- Contact your health care professional if symptoms of sleep apnea recur.
- If you notice any unexplained changes in the performance of this device, if it is making unusual or harsh sounds, if it has been dropped or mishandled, if water is spilled into the enclosure, or if the enclosure is broken, disconnect the power cord and discontinue use. Contact your home care provider.
- Repairs and adjustments must be performed by Respironics-authorized service personnel only. Unauthorized service could cause injury, invalidate the warranty, or result in costly damage.
- Periodically inspect electrical cords and cables for damage or signs of wear. Discontinue use and replace if damaged.
- To avoid electrical shock, always unplug the power cord from the wall outlet before cleaning the device. **DO NOT** immerse the device in any fluids.
- If the device is used by multiple persons (such as rental devices), a low-resistance, main flow bacteria filter should be installed in-line between the device and the circuit tubing to prevent contamination.
- Be sure to route the power cord to the outlet in a way that will prevent the cord from being tripped over or interfered with by chairs or other furniture.
- This device is activated when the power cord is connected.
- For safe operation when using a humidifier, the humidifier must always be positioned below the breathing circuit connection at the mask and the air outlet on the device. The humidifier must be level for proper operation.

Note: Please see the “Limited Warranty” section of this manual for information on warranty coverage.

Cautions

A *Caution* indicates the possibility of damage to the device.

- Pins of connectors should not be touched. Connections should not be made to these connectors unless ESD precautionary procedures are used. Precautionary procedures include methods to prevent build-up of electrostatic charge (e.g., air conditioning, humidification, conductive floor coverings, non-synthetic clothing), discharging one’s body to the frame of the equipment or system or to earth or a large metal object, and bonding oneself by means of a wrist strap to the equipment or system or to earth.
- Before operating the device, ensure that the SD card cover is replaced whenever any of the accessories such as the Link Module or Modem are not installed. Refer to the instructions that came with your accessory.
- Condensation may damage the device. If this device has been exposed to either very hot or very cold temperatures, allow it to adjust to room temperature (operating temperature) before starting therapy. Do not operate the device outside of the operating temperature range shown in the Specifications.
- Do not use extension cords with this device.
- Do not place the device directly onto carpet, fabric, or other flammable materials.
- Do not place the device in or on any container that can collect or hold water.
- A properly installed, undamaged reusable foam inlet filter is required for proper operation.
- Tobacco smoke may cause tar build-up within the device, which may result in the device malfunctioning.
- Dirty inlet filters may cause high operating temperatures that may affect device performance. Regularly examine the inlet filters as needed for integrity and cleanliness.
- Never install a wet filter into the device. You must ensure sufficient drying time for the cleaned filter.
- When DC power is obtained from a vehicle battery, the device should not be used while the vehicle’s engine is running. Damage to the device may occur.
- Only use a Respironics DC Power Cord and Battery Adapter Cable. Use of any other system may cause damage to the device.

Contraindications









When assessing the relative risks and benefits of using this equipment, the clinician should understand that this device can deliver pressures up to 25 cm H₂O. In the event of certain fault conditions, a maximum pressure of 35 cm H₂O is possible. Studies have shown that the following pre-existing conditions may contraindicate the use of CPAP therapy for some patients:

- Bullous Lung Disease
- Pathologically Low Blood Pressure
- Bypassed Upper Airway
- Pneumothorax
- Pneumocephalus has been reported in a patient using nasal Continuous Positive Airway Pressure. Caution should be used when prescribing CPAP for susceptible patients such as those with: cerebral spinal fluid (CSF) leaks, abnormalities of the cribriform plate, prior history of head trauma, and/or pneumocephalus. (Chest 1989; 96:1425-1426)

The use of positive airway pressure therapy may be temporarily contraindicated if you exhibit signs of a sinus or middle ear infection. Not for use with patients whose upper airways are bypassed. Contact your health care professional if you have any questions concerning your therapy.

Symbol Key

The following symbols may appear on the device and power supply:

SYMBOL	DEFINITION	SYMBOL	DEFINITION
	Consult accompanying instructions for use.		Separate collection for electrical and electronic equipment per EC Directive 2002/96/EC.
	For Airline Use. Complies with RTCA/DO-160F section 21, category M.		Do not disassemble.
	DC Power		Class II (Double Insulated)
	Type BF Applied Part		For Indoor Use Only.
IPX1	Drip Proof Equipment		

System Contents

Your BiPAP Auto Bi-Flex system includes the following items:

- Device
- User manual
- Carrying case
- Power cord and power supply (Part # 1058190)
- Flexible tubing, 22 mm (optional 15 mm tubing is also available)
- Reusable gray foam filter
- Disposable ultra-fine filter (optional)
- Side cover panel
- SD card
- Humidifier (optional)

Note: If any of these items are missing, contact your home care provider.

System Overview

The BiPAP Auto system offers several options in how therapy is delivered, so treatment can be personalized to meet your needs for the treatment of Obstructive Sleep Apnea (OSA).

The system can be set up as a Bi-level or Auto Bi-level device, which delivers two different positive pressure levels: IPAP (Inspiratory Positive Airway Pressure) and EPAP (Expiratory Positive Airway Pressure). The system can also be set up as a CPAP (Continuous Positive Airway Pressure) device. Your home care provider will choose the appropriate pressure settings for you.

When prescribed for you, the device provides several special features to help make your therapy more comfortable. The ramp function allows you to lower the pressure when you are trying to fall asleep. The air pressure will gradually increase until your prescription pressure is reached. You also have the option of not using the ramp feature at all.

Additionally, the Flex comfort features provide you with pressure relief when you exhale during therapy.

Several accessories are also available for use with your BiPAP Auto device. Contact your home care provider to purchase any accessories not included with your system.

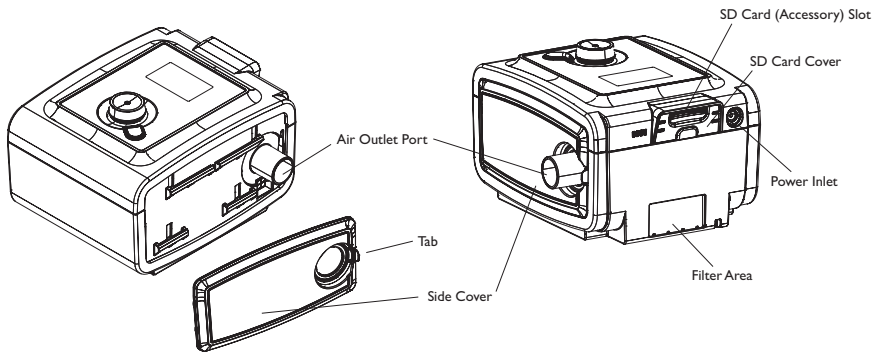

This figure illustrates some of the device features, described in the following table.

DEVICE FEATURE	DESCRIPTION
Air Outlet Port (conical, 22 mm)	Connect the flexible tubing here.
SD Card (Accessory) Slot	If applicable, insert the optional accessory SD card here.
SD Card Cover	If applicable, the optional accessories such as a Link Module or Modem can be installed here. Refer to the instructions supplied with the accessory. When not using an accessory, this cover must be in place on the device.
Power Inlet	Connect the power cord here.
Filter Area	A reusable, gray foam filter must be placed in the filter area to screen out normal household dust and pollens. A white ultra-fine filter can also be used for more complete filtration of very fine particles.
Side Cover	If using a humidifier with the device, this side cover can be easily removed with the release tab before attaching the humidifier. Refer to the humidifier manual. When not using a humidifier, this cover must be in place on the device.

Control Buttons

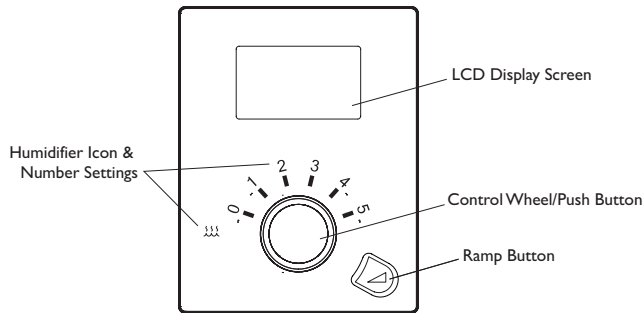

This figure shows the primary control buttons on the device, described in the following table.

FEATURE	DESCRIPTION
Display Screen	Shows therapy settings, patient data, and other messages. The startup screen is shown temporarily when the unit is first powered.
Humidifier Icon	This Icon lights up when the optional humidifier is attached and heat is being applied. The humidifier number settings are only visible when the humidifier is attached and therapy is active. Please refer to the humidifier user manual for more information.
Control Wheel/ Push Button	Turn the wheel to toggle between options on the screen. Press the wheel to choose an option. Primary function is to turn airflow on/off.
Ramp Button	When the airflow is on, this button allows you to activate or restart the ramp function. When the airflow is off, this button allows you to activate the Mask Fit Check. This button lights up when therapy is active or during specific alerts.

Available Therapies

The BiPAP Auto Bi-Flex device delivers the following therapies:

- **Bi-level** – Provides one level of output pressure during EPAP (Expiratory Positive Airway Pressure) and a second higher level during IPAP (Inspiratory Positive Airway Pressure).
- **Bi-level with Bi-Flex** – Bi-level therapy with pressure relief upon exhalation to improve patient comfort based on patient needs.
- **Auto Bi-level** – Delivers spontaneous Bi-level therapy while automatically adjusting EPAP and IPAP levels to meet the patient's needs.
- **Auto Bi-level with Bi-Flex** – Auto Bi-level therapy with pressure relief upon exhalation to improve patient comfort based on patient needs.

The following therapy modes may also be available:

- **CPAP** – Delivers Continuous Positive Airway Pressure; CPAP maintains a constant level of pressure throughout the breathing cycle.
- **CPAP with C-Flex** – Delivers CPAP therapy with pressure relief upon exhalation to improve patient comfort based on patient needs.

Installing the Air Filters

CAUTION: A properly installed, undamaged gray foam filter is required for proper operation.

The device uses a gray foam filter that is washable and reusable, and a white ultra-fine filter that is disposable. The reusable filter screens out normal household dust and pollens, while the ultra-fine filter provides more complete filtration of very fine particles. The gray reusable filter must be in place at all times when the device is operating. The ultra-fine filter is recommended for people who are sensitive to tobacco smoke or other small particles.

The reusable gray foam filter is supplied with the device. A disposable ultra-fine filter may also be included. If your filter is not already installed when you receive your device, you must at least install the reusable gray foam filter before using the device. To install the filter(s):

1. If you are using the white disposable ultra-fine filter, insert it into the filter area first, mesh-side facing in, towards the device.
2. Insert the required gray foam filter into the filter area after the ultra-fine filter.

Note: If you are not using the white disposable filter, simply insert the gray foam filter into the filter area.

Connecting the Breathing Circuit

To use the system, you will need the following accessories in order to assemble the recommended circuit:

- Respironics interface (nasal mask or full face mask) with integrated exhalation port, or Respironics interface with a separate exhalation device (such as the Whisper Swivel II)

WARNING: If you are using a full face mask (a mask covering both your mouth and your nose), the mask must be equipped with a safety (enainment) valve.

- Respironics 22 mm flexible tubing, 1.83 m (6 ft.) (optional Respironics 15 mm tubing for compatible devices)
- Respironics headgear (for the mask)

WARNING: If the device is used by multiple persons (such as rental devices), a low-resistance, main flow bacteria filter should be installed in-line between the device and the circuit tubing to prevent contamination.

To connect your breathing circuit to the device, complete the following steps:

1. Connect the flexible tubing to the air outlet on the side of the device.

WARNING: If you are using the optional Respironics 15 mm tubing, the device tubing type setting must be set to 15. If your device does not have the tubing type setting, you must use the Respironics 22 mm tubing.

Note: If required, connect a bacteria filter to the device air outlet, and then connect the flexible tubing to the outlet of the bacteria filter.

Note: When using the bacteria filter, the device performance may be affected. However, the device will remain functional and deliver therapy.

2. Connect the tubing to the mask. Refer to the instructions that came with your mask.
3. Attach the headgear to the mask if necessary. Refer to the instructions that came with your headgear.

Where to Place the Device

Place the device on a firm, flat surface somewhere within easy reach of where you will use it at a level lower than your sleeping position. Make sure the filter area on the back of the device is not blocked by bedding, curtains, or other items. Air must flow freely around the device for the system to work properly. Make sure the device is away from any heating or cooling equipment (e.g., forced air vents, radiators, air conditioners).

CAUTION: Do not place the device directly onto carpet, fabric, or other flammable materials.

CAUTION: Do not place the device in or on any container that can collect or hold water.

Supplying AC Power to the Device

CAUTION: Condensation may damage the device. If this device has been exposed to either very hot or very cold temperatures, allow it to adjust to room temperature (operating temperature) before starting therapy. Do not operate the device outside of the operating temperature range shown in the Specifications.

WARNING: Be sure to route the power cord to the outlet in a way that will prevent the cord from being tripped over or interfered with by chairs or other furniture.

WARNING: This device is activated when the power cord is connected.

IMPORTANT: If you are using your device with a humidifier, refer to the instructions included with your humidifier for details on how to power the device and humidifier.

Complete the following steps to operate the device using AC power:

1. Plug the socket end of the AC power cord (included) into the power supply (also included).
2. Plug the pronged end of the AC power cord into an electrical outlet that is not controlled by a wall switch.
3. Plug the power supply cord's connector into the power inlet on the back of the device.
4. Ensure that all connections are secure.

IMPORTANT: To remove AC power, disconnect the power supply cord from the electrical outlet.

WARNING: Periodically inspect electrical cords and cables for damage or signs of wear. Discontinue use and replace if damaged.

CAUTION: Do not use extension cords with this device.

Navigating the Device Screens

Turn the wheel to toggle between options and settings on the screen. Press the wheel to choose an option or setting that is highlighted. If you choose "Back" on any screen, it will take you back to the previous screen.

Note: The screens shown throughout this manual are examples only. Actual screens may vary slightly. Examples are for reference only.

Starting the Device

1. Supply power to the device.
2. The Home screen will appear, shown below.



Home Screen

Note: "Bi-Flex" shown above will either display a blank screen or it will show the current flex mode or "Rise time" depending on how the provider set up the device.

Note: The SD card icon will display next to "Info", if the SD card is inserted.

3. Put on your mask assembly.

Note: If you are having trouble with your mask, refer to the instructions supplied with the mask.

4. Turn the wheel to toggle between the options. Highlight "Therapy". Press the wheel to turn on the airflow and begin therapy. The Therapy screen will appear, which will show the current pressure setting being delivered (example shown below).

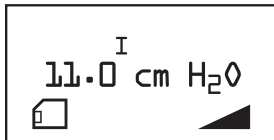

Therapy Screen

Note: "I" is displayed above the pressure setting during IPAP (Inspiratory Positive Airway Pressure) and "E" is displayed during EPAP (Expiratory Positive Airway Pressure).

Note: The SD card icon will display in the lower left corner if the SD card is inserted.

Note: If the Ramp feature is on, the Ramp icon will display in the lower right corner.

5. Make sure that no air is leaking from your mask into your eyes. If necessary, adjust the mask and headgear until the air leak stops. See the instructions provided with your mask for more information.

Note: A small amount of mask leak is normal and acceptable. Correct large mask leaks or eye irritation from an air leak as soon as possible.

6. If you are using the device in a bed with a headboard, try placing the tubing over the headboard. This may reduce tension on the mask.
7. Press the wheel again to turn off therapy and return to the Home screen.

Ramp Feature

The device is equipped with an optional ramp feature that your home care provider can enable or disable. This feature reduces the air pressure when you are trying to fall asleep and then gradually increases (ramps) the pressure until your prescription setting is reached, allowing you to fall asleep more comfortably.

If ramp is enabled on your device, after you turn on the airflow, press the RAMP () button on the top of the device. You can use the RAMP button as often as you wish during the night.

Note: If the Ramp feature is on, the Ramp icon () will display in the lower right corner of the Therapy screen.

Note: If the Ramp feature is disabled and airflow is on, nothing will happen when you press the RAMP button.

Note: If the airflow is off and you press the RAMP button, the mask fit check feature will start if it is enabled by your provider.

Note: If in Auto mode, there is no ramp at minimum pressure when starting. Ramp would only be useful if you wake in the middle of the night.



Mask Fit Check Feature

If available on your device, the optional mask fit check feature can be enabled or disabled by your home care provider. This feature allows you to check the fit of your mask prior to starting therapy. This is done by measuring the amount of leak.

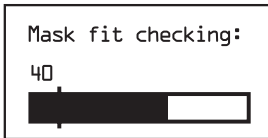
Put on your mask assembly. If mask fit check is enabled, before you turn on the airflow, press the RAMP () button on the top of the device. Airflow will start and the mask fit check screen will appear, shown below.



Mask Fit Check

The device will deliver a test pressure while the screen will count down 40 seconds. After the test, normal therapy will start and the screen will either display a checkmark () or an X. The  shows that the leak found allows for optimal performance of the device. The X shows that the leak may affect device performance, however, the device will remain functional and deliver therapy.

Note: If you choose to try to improve your mask fit, you can stop therapy, adjust the fit of your mask, and rerun the Mask Fit Check. Please refer to the instructions that came with your mask and headgear for the proper fitting procedure.

Note: Mask Fit Check is only available when the device is in Auto Bi-level therapy mode.

Note: If Split night is enabled, Mask Fit Check will be disabled.

Flex/Rise time Screen

From the Home screen, highlight “Flex” or “Rise time” and press the wheel. The following screen will appear.

Note: This screen will be blank on the Home screen if your provider has not enabled Flex or Rise time on your device.

Bi-Flex	Back			
	Bi-Flex	1	2	3
	Rise time	1	2	3
	Bi-Flex demo	1	2	3
	Rise time demo	1	2	3

Flex Screen

Note: “Bi-Flex” shown above will display as the current Flex mode chosen by the provider.

- **Flex** - The Flex comfort feature allows you to adjust the level of air pressure relief that you feel when you exhale during therapy. Your home care provider can enable or disable this feature. When your provider enables Flex, a level will already be set for you on the device. If this is not comfortable, you can increase or decrease the setting. The setting of “1” provides a small amount of pressure relief, with higher numbers providing additional relief. If the provider has disabled this feature, this setting will not display.

Note: This same setting is also available under the “Setup” screen.

- **Rise time** - Rise time is the time it takes for the device to change from EPAP to IPAP. This screen allows you to adjust the rise time so you can find the desired setting. This is only available if the device is in Bi-level or Auto Bi-level mode and Bi-Flex has been disabled.
 - 1 sets Rise Time to 1 (200 msec).
 - 2 sets Rise Time to 2 (300 msec).
 - 3 sets Rise Time to 3 (400 msec).

Note: This setting will not display if your provider has not enabled Rise time on your device.

Note: This same setting is also available under the “Setup” screen.

- **Flex demo** - The Flex setting allows you to set the Flex level prior to beginning therapy. The Flex demo setting allows you to try out the different Flex settings in real time. After a period of time of inactivity, the device will stop therapy and will use the last Flex demo setting as the new Flex setting for your device. When therapy is again started from the Home screen, the device will operate using the new Flex setting. If the provider has disabled this feature, this setting will not display.
- **Rise time demo** - The Rise time demo setting allows you to try out the different Rise time settings in real time. After a period of time of inactivity, the device will stop therapy and will use the last Rise time demo setting as the new Rise time setting for your device. When therapy is again started from the Home screen, the device will operate using the new Rise time setting. If the provider has disabled this feature, this setting will not display.

Setup Screen

From the Home screen, highlight “Setup” and press the wheel. The following Setup screen will appear. The user can change settings in the Setup menu.

Setup	Back						
	Flex	1	2	3			
	Rise time	1	2	3			
	SYSTEM ONE humidification				on	off	
	Humidifier	0	1	2	3	4	5
	Ramp start	4.0 - (min EPAP / CPAP pres)					
	Tubing type	15	22				
	SYSTEM ONE resistance		X1	X2	X3	X4	X5
	Auto on		on	off			
	Auto off		on	off			
	Mask alert		on	off			
	Humidifier LED Backlight				on	off	
	Language	EN	ES				
	Back						

Setup Screen

Note: The screen will only show 4 lines at a time. As you rotate the wheel to toggle over different options the screen will slide up and down accordingly. If the text is too long to completely fit on the screen, it will scroll horizontally across the screen when highlighted.

- **Flex** - The Flex comfort feature allows you to adjust the level of air pressure relief that you feel when you exhale during therapy. Your home care provider can enable or disable this feature. When your provider enables Flex, a level will already be set for you on the device. If this is not comfortable, you can increase or decrease the setting. The setting of “1” provides a small amount of pressure relief, with higher numbers providing additional relief. If the provider has disabled this feature, this setting will not display.

Note: “Flex” shown above will display as the current Flex mode chosen by the provider.

Note: This same setting is also available under the “Flex/Rise time” screen.

- **Rise time** - Rise time is the time it takes for the device to change from EPAP to IPAP. This screen allows you to adjust the rise time so you can find the desired setting. This is only available if the device is in Bi-level or Auto Bi-level mode and Bi-Flex has been disabled.
 - 1 sets Rise Time to 1 (200 msec).
 - 2 sets Rise Time to 2 (300 msec).
 - 3 sets Rise Time to 3 (400 msec).

Note: This setting will not display if your provider has not enabled Rise time on your device.

Note: This same setting is also available under the “Flex/Rise time” screen.

- **SYSTEM ONE humidification** - System One humidity control maintains a consistent mask humidity by monitoring and adjusting for changes in room temperature and room humidity. You can enable or disable this feature. If the System One humidity control has been disabled, the classic style of basic temperature controlled heated humidification will be used. This will only display if the humidifier is attached.
- **Humidifier** - This setting allows you to choose the desired humidity setting: 0, 1, 2, 3, 4 or 5. If the System One humidity control has been disabled, the classic style of basic temperature controlled heated humidification will be used and the display will show: 0, C1, C2, C3, C4 or C5 for these settings. This will only display if the humidifier is attached. Please refer to the humidifier manual if using a humidifier.
- **Ramp Start** - This displays the ramp starting pressure. You can increase or decrease the ramp starting pressure in 0.5 cm H₂O increments. This will not display if your provider set Ramp time to zero or enabled Split night on your device.

- **Tubing Type** - This setting allows you to select the correct size diameter tubing that you are using with the device. You can choose either “22” for any Respirationics 22 mm tubing, or “15” for the optional Respirationics 15 mm tubing.
WARNING: If you are using the optional Respirationics 15 mm tubing, the device tubing type setting must be set to 15. If your device does not have the tubing type setting, you must use the Respirationics 22 mm tubing.
- **SYSTEM ONE resistance ( ←)** - This setting allows you to adjust the level of air pressure relief based on the specific Respirationics mask. Each Respirationics mask may have a “System One” resistance control setting. Contact your home care provider if you cannot find this resistance setting for your mask. If your provider has locked the resistance setting into place, you can view the setting but cannot change it, and the screen will display a lock symbol. If your provider has disabled resistance, you will not see this setting.
- **Auto on** - You can enable this feature if you want the device to automatically turn the airflow on whenever you apply the interface (mask) to your airway. You can also disable this feature.
- **Auto off** - You can enable this feature if you want the device to automatically turn the airflow off whenever you remove the interface (mask) from your airway. You can also disable this feature.
- **Mask alert** - You can enable or disable the mask alert setting. If this feature is enabled, the mask alert will appear on the display screen when a significant mask leak is detected, and an audible alert will sound. Refer to the Device Alerts section for more information about the mask alert.
- **Humidifier LED Backlight (Ramp Backlight)** - You can enable or disable the LED backlight for the humidifier number settings and Ramp button on the device.
Note: If the humidifier is not attached, this feature will display as “Ramp Backlight” and control the LED backlight for the Ramp button only.
Note: If the Humidifier LED Backlight is enabled or disabled, the humidifier icon will always remain on (if humidifier is attached and heat is being applied), but will dim after 30 seconds of inactivity.
- **Language** - This feature allows you to choose which language to display on the interface. You can choose English (EN) or Spanish (ES).

Info Screen



From the Home screen, highlight “Info” and press the wheel. The following Info screen will appear. The user cannot change settings in the Info menu.

Note: These screens are only for reference. Your home care provider may periodically ask you for this information.



Info Screen

Note: The screen will only show 4 lines at a time. As you rotate the wheel to toggle over different options the screen will slide up and down accordingly.

- **Status** - This displays information sent from a peripheral (SD card  , modem  , etc.). If two peripherals are attached, two lines will appear with corresponding icons.

Note: This will not display if no peripherals are being used.

- **Phone-in** - This screen displays the total therapy hours for the device, the total blower hours, and the total number of days used when the sessions were greater than 4 hours since the device was last reset by the home care provider. This screen also displays a compliance check number used by your home care provider to validate that the data provided by you is the data taken from this screen. This setting only appears if your provider has enabled this feature.
- **Compliance VIC (Visual Inspection Check)** - This screen displays the start day and the total number of days used when the sessions were greater than 4 hours. This screen also displays a check code number used by your home care provider to validate that the data provided by you is the data taken from this screen. This setting only appears if your provider has enabled this feature.
- **Therapy hours** - The device is capable of recognizing the difference between the time the patient is actually receiving therapy and the time when the blower is simply running. This screen displays the average amount of time the patient is actually receiving therapy on the device over a 7 day and 30 day time frame (provided the device has at least 7 or 30 days of data respectively). If the device has only 5 days of data to use for the calculation, the 5 day average value will be seen under the 7 day display.
- **Days > 4** - This screen displays the cumulative number of device therapy sessions that exceeded 4 hours over a 7 day and 30 day time frame.
- **Large leak** - During any given night, the device recognizes the percentage of time the patient was experiencing what it deemed to be a large leak. Large leak is defined as the level of leak that is so large, it is no longer possible to determine respiratory events with statistical accuracy. This screen displays the average of these individual nightly values of percentage of time in large leak over a 7 day and 30 day time frame (provided the device has at least 7 or 30 days of data respectively). If the device has only 5 days of data to use for the calculation, the 5 day average value will be seen under the 7 day display. If you see a large increase in the percent of time in large leak indicated here, contact your home care provider for assistance. This screen only displays if your home care provider has enabled it.
- **AHI** - The device accumulates individual Apnea/Hypopnea indices (AHI) for each session the patient used the device. This screen displays the average of these individual nightly AHI values over a 7 day and 30 day time frame (provided the device has at least 7 or 30 days of data respectively). If the device has only 5 days of data to use for the calculation, the 5 day average value will be seen under the 7 day display. This screen only displays if your home care provider has enabled it.
- **Periodic Breathing** - During any given night, the device recognizes the percentage of time the patient was experiencing periodic breathing. This screen displays the average of these individual nightly values of periodic breathing over a 7 day and 30 day time frame (provided the device has at least 7 or 30 days of data respectively). If the device has only 5 days of data to use for the calculation, the 5 day average value will be seen under the 7 day display. If you see a large increase in the percent of time in periodic breathing indicated here, contact your home care provider for assistance. This screen only displays if your home care provider has enabled it.
- **90% Pressure** - During any given night, the device recognizes the 90% Pressure achieved by the Auto Algorithm. 90% Pressure is defined as the pressure at which the device spent 90% of the session time at or below. For example, if the device recognized airflow for 10 hours, and 9 hours were spent at or below 11 cm H₂O, and 1 hour was spent above 11 cm H₂O, then the 90% Pressure would be 11 cm H₂O. This screen displays the average of these individual nightly values of 90% Pressure over a 7 day and 30 day time frame (provided the device has at least 7 or 30 days of data respectively). If the device has only 5 days of data to use for the calculation, the 5 day average value will be seen under the 7 day display. Each average will display 2 numbers. The first number shown is the IPAP average, while the second number shown is the EPAP average. This screen only displays if you are in Auto Bi-level therapy.

Device Alerts

- **High Priority:** These alerts require immediate operator response. The alert signal consists of a high priority sound, which is a continuous two-beep pattern (indicated in the following table as: • • ••). Additionally, the backlights on the buttons will provide a high priority flashing pattern consisting of a continuous, bright-to-off, two-flash pattern (indicated in the following table as: ◇ ◇).
- **Medium Priority:** These alerts require prompt operator response. The alert signal consists of a medium priority sound, which is a continuous one-beep pattern (indicated in the following table as: • •). Additionally, the backlights on the buttons will provide a medium priority flashing pattern consisting of a continuous, bright-to-dim, one-flash pattern (indicated in the following table as: ◇ ◇).

Alert Summary Table: The following table summarizes the alerts.

ALERT	AUDIBLE INDICATOR	VISUAL INDICATOR	DEVICE ACTION	POSSIBLE CAUSE	PATIENT ACTION
Service Required	• • ••	◇ ◇ Screen displays "Service required", indicating that service is required.	The device enters the "Safe state" in which the device power remains on, but the airflow is disabled.	Device failure.	Press either the wheel or ramp button to silence the alert. Remove the power supply cord from the device to remove power. Plug the cord back into the device's power inlet to restore power. If the alert continues to occur, contact your home care provider.
Mask Alert	• •	◇ ◇ Screen displays "Mask alert".	Alert present until action is taken.	The breathing circuit is disconnected or there is a large air leak.	Turn off airflow. Check your breathing circuit connections and reconnect the tubing if it has come loose. Make sure your mask is on properly before you restart the airflow. If the alert continues to occur, contact your home care provider to have your mask checked. You may need a mask refitting.
Auto Off	single beep	Screen displays "Auto off".	The airflow shuts off and the device enters the Standby state approximately 45-60 seconds after detection. Alert present for 30 seconds or until user acknowledges.	The mask has been removed.	Put your mask back on and turn the airflow on to resume therapy.
Humidifier Alert	none	◇ ◇ Humidifier LED icon will flash. 	Only displayed when both the humidifier and therapy is on.	Humidifier failure.	Alert is present for 12 minutes or until the condition is fixed. Turn off airflow and reconnect the humidifier to the device according to the humidifier instructions. If the alert continues to occur, contact your home care provider.

ALERT	AUDIBLE INDICATOR	VISUAL INDICATOR	DEVICE ACTION	POSSIBLE CAUSE	PATIENT ACTION
Patient Reminder	single beep	Screen displays message from the provider.	Only displayed when therapy transitions from on to off. Alert present for 6 minutes or until user acknowledges.	Message from the provider.	Your home care provider may set a patient reminder scheduled to pop up at a particular time to remind you to replace your mask, change your filters, etc. "Check your mask, a new one may be available. Call your provider:" is the default message. The provider may change the message.
Instant Message	single beep	Home care provider will supply text to be displayed.	Only displayed when therapy is off.	Message from the provider.	Your home care provider may send an instant message. Contact your home care provider with any questions.
SD Card: Prescription Accepted	single beep	Screen displays "SD card inserted, prescription accepted".	Alert present for 30 seconds or until user acknowledges.	n/a	Card status can be checked in Status menu.
SD Card: Prescription Rejected	single beep	◇ ◇ Screen displays "SD card inserted, prescription rejected".	Alert present for 30 seconds or until user acknowledges.	Prescription missing or incorrect.	Contact your home care provider for correct prescription.
SD Card: Inserted Incorrectly	• •	◇ ◇ Screen displays "SD card inserted incorrectly".	Alert present until action is taken.	SD card inserted incorrectly.	Alert is present until card is removed. Remove SD card and reinsert correctly. If the alert continues to occur, contact your home care provider.
SD Card: Full	• •	◇ ◇ Screen displays "SD card full".	Alert present until action is taken.	SD card is full.	Alert is present until card is removed. Card status can be checked in the Status menu. Remove SD card and replace.
SD Card: Remove	single beep	◇ ◇ Screen displays "SD card removed".	Alert present for 30 seconds or until user acknowledges.	SD card has been removed.	No action needed.
SD Card: Data Activity	single beep	Screen displays "Data activity: Do not remove card".	Alert present until user acknowledges or data activity complete.	n/a	Only displayed immediately after therapy is turned off when data is transferring to the card.

ALERT	AUDIBLE INDICATOR	VISUAL INDICATOR	DEVICE ACTION	POSSIBLE CAUSE	PATIENT ACTION
SD Card: Corrupt	• •	◇ ◇ Screen displays "Corrupt card inserted reformat card?".	Alert present until action is taken.	A problem exists with the SD card.The data may be corrupted.	Choose "yes" to reformat the card. Screen displays "Reformatting... do not remove card". If you choose no, the alert will disappear and the card will not be reformatted. Note:Any information on the card will be lost when reformatted. Contact your home care provider with any questions.
SD Card: Remove and Reinsert	• •	◇ ◇ Screen displays "SD card error: remove and reinsert".	Alert present until action is taken.	Device cannot read the SD card.A problem may exist with the SD card or it is inserted incorrectly.	Remove SD card and reinsert. If the alert continues to occur, replace with another card or contact your home care provider.
Modem: Making Call	single beep	Modem will display its own icon on the device. Refer to modem instruction manual.	Alert present for 30 seconds after call sequence or until user acknowledges.	Refer to modem instruction manual.	If modem is making call while therapy is active, alert for call sequence is not displayed.
Modem: Unsuccessful Call	single beep	◇ ◇ Modem will display its own icon on the device. Refer to modem instruction manual.	Alert present for 30 seconds or until user acknowledges.	Refer to modem instruction manual.	No action needed.

Troubleshooting

The table below lists some of the problems you may experience with your device and possible solutions to those problems.

PROBLEM	WHY IT HAPPENED	WHAT TO DO
Nothing happens when you apply power to the device. The backlights on the buttons do not light.	There's no power at the outlet or the device is unplugged.	<p>If you are using AC power, check the outlet and verify that the device is properly plugged in. Make sure there is power available at the outlet. Make sure the AC power cord is connected correctly to the power supply and the power supply cord is securely connected to the device's power inlet. If the problem continues to occur, contact your home care provider. Return both the device and power supply to your provider, so they can determine if the problem is with the device or power supply.</p> <p>If you are using DC power, make sure your DC power cord and battery adaptor cable connections are secure. Check your battery. It may need recharged or replaced. If the problem persists, check the DC cord's fuse following the instructions supplied with your DC cord. The fuse may need to be replaced. If the problem still occurs, contact your home care provider.</p>
The airflow does not turn on.	There may be a problem with the blower.	Make sure the device is powered correctly. Make sure "Therapy" is highlighted when pressing the control wheel to start airflow. If the airflow does not turn on, there may be a problem with your device. Contact your home care provider for assistance.
The device's display is erratic.	The device has been dropped or mishandled, or the device is in an area with high Electromagnetic Interference (EMI) emissions.	Unplug the device. Reapply power to the device. If the problem continues, relocate the device to an area with lower EMI emissions (away from electronic equipment such as cellular phones, cordless phones, computers, TVs, electronic games, hair dryers, etc.). If the problem still occurs, contact your home care provider for assistance.
The Ramp feature does not work when you press the Ramp button.	Your home care provider did not prescribe Ramp for you, or your prescription pressure is already set to the minimum setting.	<p>If Ramp has not been prescribed for you, discuss this feature with your home care provider to see if they will change your prescription.</p> <p>If your provider has enabled Ramp, but the feature still does not work, check the pressure setting on the Therapy screen. If it is set to the minimum setting (4.0 cm H₂O), the Ramp feature will not work.</p>
The airflow is much warmer than usual.	<p>The air filters may be dirty.</p> <p>The device may be operating in direct sunlight or near a heater.</p>	<p>Clean or replace the air filters.</p> <p>The temperature of the air may vary somewhat based on your room temperature. Make sure that the device is properly ventilated. Keep the device away from bedding or curtains that could block the flow of air around the device. Make sure the device is away from direct sunlight and heating equipment.</p> <p>If using the humidifier with the device, check the humidifier settings. Refer to the humidifier instructions to make sure the humidifier is working properly.</p> <p>If the problem continues, contact your home care provider.</p>
The airflow pressure feels too high or too low.	The Tubing type setting may be incorrect.	<p>Make sure the Tubing type setting (22 or 15) matches the tubing that you are using (Respironics 22 mm tubing, or the optional Respironics 15 mm tubing).</p> <p>If you do not see the Tubing type setting in the setup menu, you must use the Respironics 22 mm tubing.</p>

Accessories

There are several accessories available for your BiPAP Auto Bi-Flex system such as a humidifier or a modem. Contact your home care provider for additional information on the available accessories. When using optional accessories, always follow the instructions enclosed with the accessories.

CAUTION: Pins of connectors should not be touched. Connections should not be made to these connectors unless ESD precautionary procedures are used. Precautionary procedures include methods to prevent build-up of electrostatic charge (e.g., air conditioning, humidification, conductive floor coverings, non-synthetic clothing), discharging one's body to the frame of the equipment or system or to earth or a large metal object, and bonding oneself by means of a wrist strap to the equipment or system or to earth.

Adding a Humidifier

You can use the Heated humidifier or the Passover humidifier with your device. They are available from your home care provider. A humidifier may reduce nasal dryness and irritation by adding moisture to the airflow.

WARNING: For safe operation, the humidifier must always be positioned below the breathing circuit connection at the mask and the air outlet on the device. The humidifier must be level for proper operation.

Note: Refer to the humidifier's instructions for complete setup information.

Using the SD Card

The BiPAP Auto Bi-Flex system comes with an SD card inserted in the SD card slot on the back of the device to record information for the home care provider. Your home care provider may ask you to periodically remove the SD card and send it to them for evaluation.

Note: If the SD card is inserted in the device, the SD card icon () will display next to "Info" on the Home screen and it will also display in the lower left corner of the Therapy screen.

Note: The SD card does not need to be installed for the device to work properly. The SD card records device usage information for your home care provider. You can refer to the Device Alerts section in this manual for more information on the SD card. Contact your provider if you have any questions about the SD card.

Adding Supplemental Oxygen

Oxygen may be added at the mask connection. Please note the warnings listed below when using oxygen with the device.

WARNINGS:

- When using oxygen with this system, the oxygen supply must comply with local regulations for medical oxygen.
- Oxygen supports combustion. Oxygen should not be used while smoking or in the presence of an open flame.
- When using oxygen with this system, a Respirationics Pressure Valve must be placed in-line with the patient circuit between the device and the oxygen source. The pressure valve helps prevent the backflow of oxygen from the patient circuit into the device when the unit is off. Failure to use the pressure valve could result in a fire hazard.

Note: Refer to the pressure valve's instructions for complete setup information.

- When using oxygen with this system, turn the device on before turning on the oxygen. Turn the oxygen off before turning the device off. This will prevent oxygen accumulation in the device.
- Do not connect the device to an unregulated or high pressure oxygen source.

Supplying DC Power to the Device

The Respirationics DC Power Cord can be used to operate this device in a stationary recreational vehicle, boat, or motor home. The Respirationics DC Battery Adapter Cable, when used with the DC Power Cord, enables the device to be operated from a 12 VDC free-standing battery.

CAUTION: When DC power is obtained from a vehicle battery, the device should not be used while the vehicle's engine is running. Damage to the device may occur.

CAUTION: Only use a Respirationics DC Power Cord and Battery Adapter Cable. Use of any other system may cause damage to the device.

Refer to the instructions supplied with the DC Power Cord and adapter cable for information on how to operate the device using DC power.

Traveling with the System

When traveling, the carrying case is for carry-on luggage only. The carrying case will not protect the system if it is put through checked baggage.

For your convenience at security stations, there is a note on the bottom of the device stating that it is medical equipment and is suitable for airline use. It may be helpful to bring this manual along with you to help security personnel understand the BiPAP Auto Bi-Flex device.

If you are traveling to a country with a line voltage different than the one you are currently using, a different power cord or an international plug adaptor may be required to make your power cord compatible with the power outlets of the country to which you are traveling. Contact your home care provider for additional information.

Airline Travel

The BiPAP Auto Bi-Flex device is suitable for use on airlines when the device is operating from an AC or DC power source.

Note: It is not suitable for airline use with any of the modems or humidifiers installed in the unit.

Cleaning the Device

WARNING: To avoid electrical shock, always unplug the power cord from the wall outlet before cleaning the device. DO NOT immerse the device in any fluids.

1. Unplug the device, and wipe the outside of the device with a cloth slightly dampened with water and a mild detergent. Let the device dry completely before plugging in the power cord.
2. Inspect the device and all circuit parts for damage after cleaning. Replace any damaged parts.

Cleaning or Replacing the Filters

Under normal usage, you should clean the gray foam filter at least once every two weeks and replace it with a new one every six months. The white ultra-fine filter is disposable and should be replaced after 30 nights of use or sooner if it appears dirty. DO NOT clean the ultra-fine filter.

CAUTION: Dirty inlet filters may cause high operating temperatures that may affect device performance.

Regularly examine the inlet filters as needed for integrity and cleanliness.

1. If the device is operating, stop the airflow. Disconnect the device from the power source.
2. Remove the filter(s) from the enclosure by gently squeezing the filter in the center and pulling it away from the device.
3. Examine the filter(s) for cleanliness and integrity.
4. Wash the gray foam filter in warm water with a mild detergent. Rinse thoroughly to remove all detergent residue. Allow the filter to air dry completely before reinstalling it. If the foam filter is torn, replace it. (Only Respironics-supplied filters should be used as replacement filters.)
5. If the white ultra-fine filter is dirty or torn, replace it.
6. Reinstall the filters, inserting the white ultra-fine filter first if applicable.

CAUTION: Never install a wet filter into the device. You must ensure sufficient drying time for the cleaned filter.

Cleaning the Tubing

Clean the tubing before first use and daily. Disconnect the flexible tubing from the device. Gently wash the tubing in a solution of warm water and a mild detergent. Rinse thoroughly. Air dry.

Service

The device does not require routine servicing.

WARNING: If you notice any unexplained changes in the performance of this device, if it is making unusual or harsh sounds, if it has been dropped or mishandled, if water is spilled into the enclosure, or if the enclosure is broken, disconnect the power cord and discontinue use. Contact your home care provider.

Specifications

Environmental

- Operating Temperature: 5° to 35° C (41° to 95° F)
- Storage Temperature: -20° to 60° C (-4° to 140° F)
- Relative Humidity (operating & storage): 15 to 95% (non-condensing)
- Atmospheric Pressure: 101 to 77 kPa (0 - 2286 m / 0 - 7500 ft)

Physical

- Dimensions: 18 x 14 x 10 cm (7" L x 5.5" W x 4" H)
- Weight (Device with power supply): Approximately 1.53 kg (3.37 lbs)

Standards Compliance

This device is designed to conform to the following standards:

- IEC 60601-1 General Requirements for Safety of Medical Electrical Equipment
- EN ISO 17510-1 Sleep Apnea Breathing Therapy Devices
- EN 60601-1-2 Electromagnetic Compatibility
- RTCA/DO-160F section 21, category M; Emission of Radio Frequency Energy

IEC 60601-1 Classification

- Type of Protection Against Electric Shock: Class II Equipment
- Degree of Protection Against Electric Shock: Type BF Applied Part
- Degree of Protection against Ingress of Water (device & AC power supply): Drip Proof, IPX1
- Mode of Operation: Continuous

Electrical

- AC Power Consumption: 100 – 240 VAC, 50/60 Hz, 2.1 A
- DC Power Consumption: 12VDC, 5.0 A
- Fuses: There are no user-replaceable fuses.

Noise

- Sound Pressure Level: < 30 dB(A)
- This measurement applies to the therapy device with or without the optional Humidifier.
- Sound Power Level: < 38 dB(A)

Pressure Accuracy

- Auto Bi-level/Bi-level Pressure Increments: 4.0 to 25.0 cm H₂O (in 0.5 cm H₂O increments)
- Auto Bi-level/Bi-level Pressure Stability:

	Static	Dynamic < 10 cm H ₂ O	Dynamic ≥ 10.0 to 25 cm H ₂ O
Device	± 0.5 cm H ₂ O	≤ 0.5 cm H ₂ O	≤ 1.0 cm H ₂ O
Device w/ Humidifier	± 0.5 cm H ₂ O	≤ 0.5 cm H ₂ O	≤ 1.0 cm H ₂ O

- CPAP Pressure Increments: 4.0 to 20.0 cm H₂O (in 0.5 cm H₂O increments)
- CPAP Pressure Stability:

	Static	Dynamic < 10 cm H ₂ O	Dynamic ≥ 10.0 to 20 cm H ₂ O
Device	± 0.5 cm H ₂ O	≤ 0.5 cm H ₂ O	≤ 1.0 cm H ₂ O
Device w/ Humidifier	± 0.5 cm H ₂ O	≤ 0.5 cm H ₂ O	≤ 1.0 cm H ₂ O

Maximum Flow Rate (typical)

Auto Bi-level/Bi-level:

		Test pressures (cm H ₂ O)				
		4.0	9.0	14.5	20.0	25.0
22 mm tubing	Measured pressure at the patient connection port (cm H ₂ O)	3.6	8.5	13.5	19.0	24.1
	Average flow at the patient connection port (l/min)	84.1	145.2	153.9	128.7	138.9
15 mm tubing	Measured pressure at the patient connection port (cm H ₂ O)	3.8	8.0	13.5	19.0	24.0
	Average flow at the patient connection port (l/min)	85.1	122.3	120.6	119.2	138.5

CPAP:

		Test pressures (cm H ₂ O)				
		4.0	8.0	12.0	16.0	20.0
22 mm tubing	Measured pressure at the patient connection port (cm H ₂ O)	3.6	7.5	11.0	15.0	19.0
	Average flow at the patient connection port (l/min)	84.1	135.2	154.5	146.9	128.7
15 mm tubing	Measured pressure at the patient connection port (cm H ₂ O)	3.8	7.0	11.0	15.0	19.0
	Average flow at the patient connection port (l/min)	85.1	120.7	121.6	119.3	119.2

Disposal

Separate collection for electrical and electronic equipment per EC Directive 2002/96/EC. Dispose of this device in accordance with local regulations.

How to Contact Respironics

To have your device serviced, contact your home care provider. If you need to contact Respironics directly, call the Respironics Customer Service department at 1-800-345-6443 or 1-724-387-4000. You can also use the following address:

Respironics, Inc.
1001 Murry Ridge Lane
Murrysville, PA 15668

Limited Warranty

Respironics, Inc. warrants that the system shall be free from defects of workmanship and materials and will perform in accordance with the product specifications for a period of two (2) years from the date of sale by Respironics, Inc. to the dealer. If the product fails to perform in accordance with the product specifications, Respironics, Inc. will repair or replace – at its option – the defective material or part. Respironics, Inc. will pay customary freight charges from Respironics, Inc. to the dealer location only. This warranty does not cover damage caused by accident, misuse, abuse, alteration, water ingress, and other defects not related to material or workmanship. The Respironics, Inc. Service department shall examine any devices returned for service, and Respironics, Inc. reserves the right to charge an evaluation fee for any returned device as to which no problem is found after investigation by Respironics, Inc. Service.

This warranty is non-transferable by unauthorized distributors of Respironics, Inc. products and reserves the right to charge dealers for warranty service of failed product not purchased directly from Respironics or authorized distributors.

Respironics, Inc. disclaims all liability for economic loss, loss of profits, overhead, or consequential damages which may be claimed to arise from any sale or use of this product. Some states do not allow the exclusion or limitation of incidental or consequential damages, so the above limitation or exclusion may not apply to you.

This warranty is given in lieu of all other express warranties. In addition, any implied warranties – including any warranty of merchantability or fitness for the particular purpose – are limited to two years. Some states do not allow limitations on how long an implied warranty lasts, so the above limitation may not apply to you. This warranty gives you specific legal rights, and you may also have other rights which vary from state to state.

To exercise your rights under this warranty, contact your local authorized Respironics, Inc. dealer or contact Respironics, Inc. at:

1001 Murry Ridge Lane
Murrysville, Pennsylvania 15668-8550
1-724-387-4000

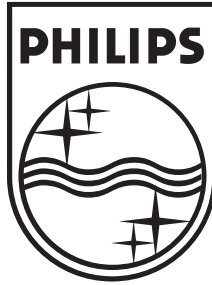

Respironics Inc.
1001 Murry Ridge Lane
Murrysville, PA 15668 USA



REF 1061635

1061627 R03
JR 9/28/2010
EN-DOM